



# LES VERRIÈRES



Attente nouvelle  
photo

- [La verrière bois](#) [P.4](#)
- [Pose en baie](#) [P.5](#)
- [Pose avec ouverture latérale](#) [P.7](#)
- [Pose sol / plafond](#) [P.9](#)
- [Verrière d'angle](#) [P.10](#)



# VERRIÈRES BOIS

## NOS CONFIGURATIONS:

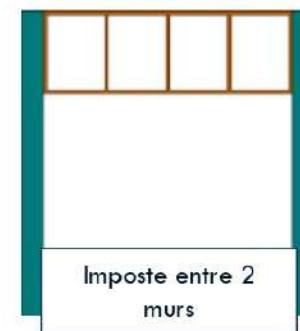
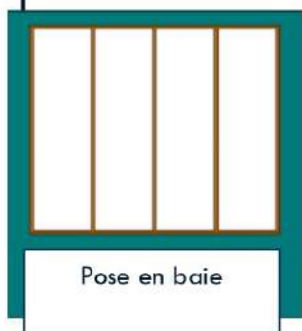

### Coupe du profil extérieur

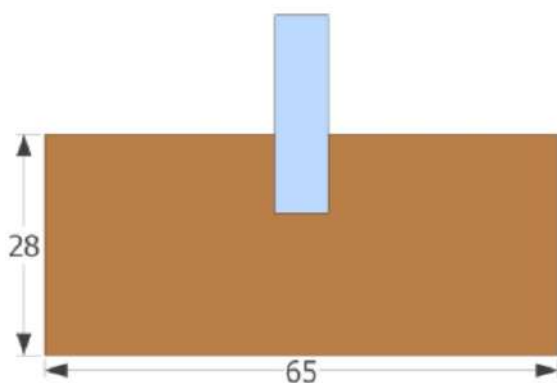

### Coupe de la traverse

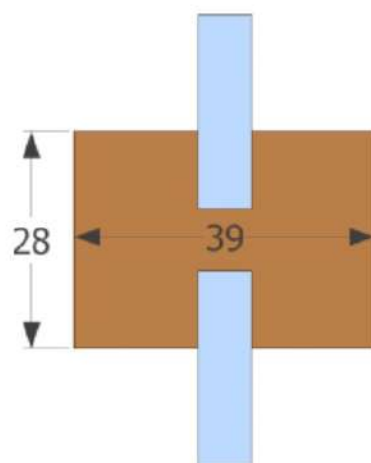

### DIMENSIONS :

Largeur minimum = 300 mm  
 Hauteur de 300 à 1200 = Largeur jusqu'à 2500  
 Hauteur de 1201 à 1600 = Largeur jusqu'à 2200  
 Hauteur de 1601 à 2500 = Largeur jusqu'à 1200

### EN OPTION:

Pan coupé

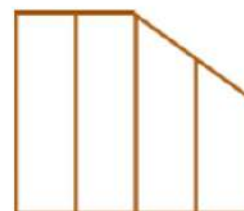

Soubassement

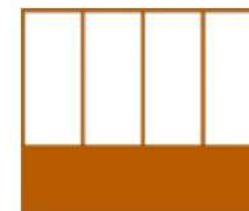



# VERRIÈRES BOIS – POSE EN BAIE

**Coupe horizontale**

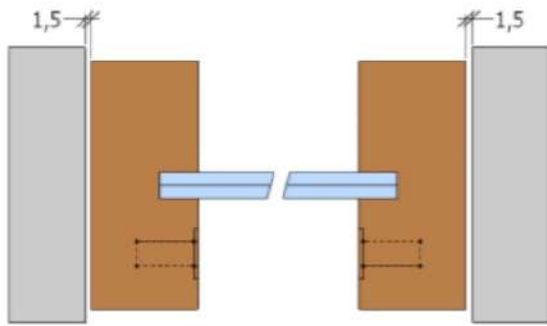

**Coupe haute**

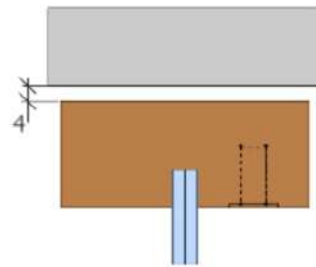

**Coupe basse**

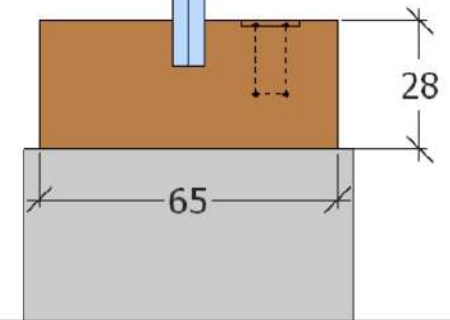
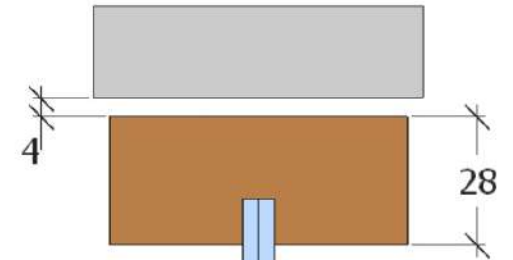
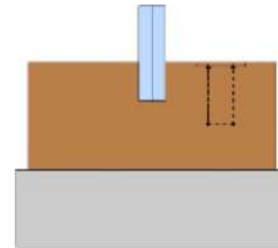



## VERRIÈRES BOIS – POSE EN BAIE

1. Faire déboucher les trous nécessaires pour la fixation
2. Positionner la verrière
3. Vérifier si la verrière est de niveau
4. Visser la verrière
5. Boucher les trous à l'aide des bouchons obturateur
6. Finition : Laisser le jeu apparent en partie haute ou placer un joint acrylique pour dissimuler le jeu

1



2



3

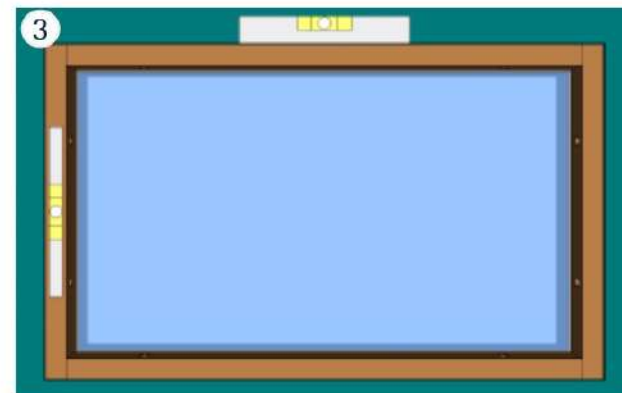

4



5



6





## VERRIÈRES BOIS – POSE AVEC OUVERTURE LATÉRALE

Coupe horizontale

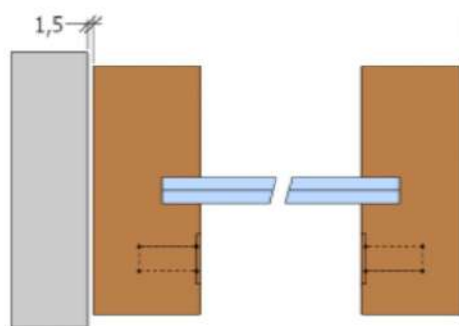

Coupe haute

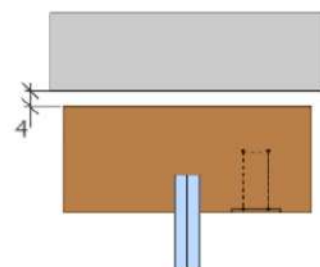

Coupe basse

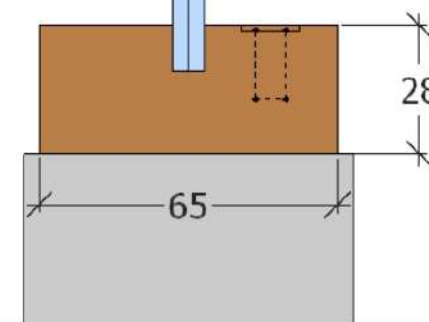
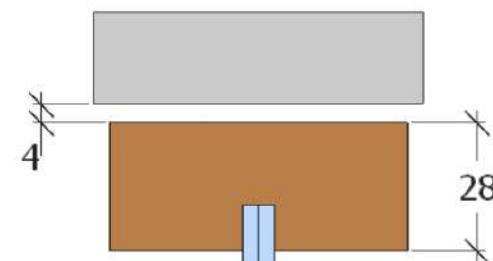
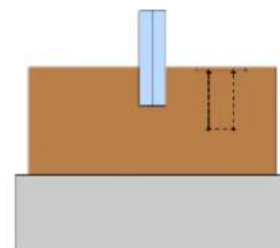



## VERRIÈRES BOIS – POSE AVEC OUVERTURE LATÉRALE

1. Faire déboucher les trous nécessaire pour la fixation
2. Positionner la verrière
3. Vérifier si la verrière est de niveau
4. Visser la verrière
5. Boucher les trous à l'aide des bouchons obturateur
6. Finition : Laisser le jeu apparent en partie haute ou placer un joint acrylique pour dissimuler le jeu

1



2

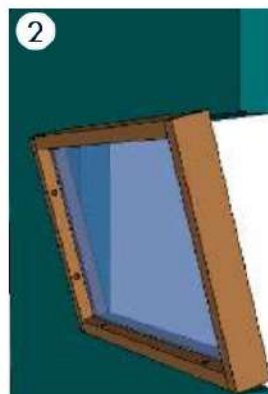

3

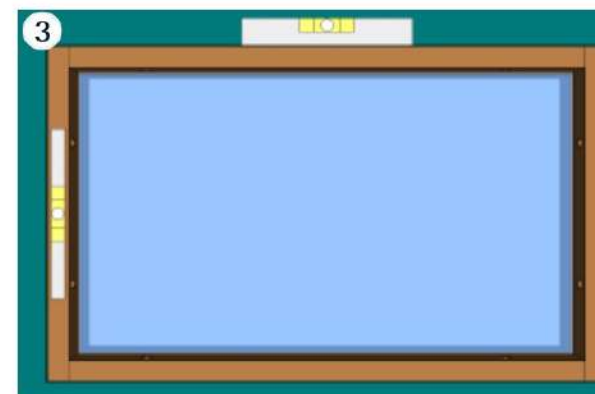

4

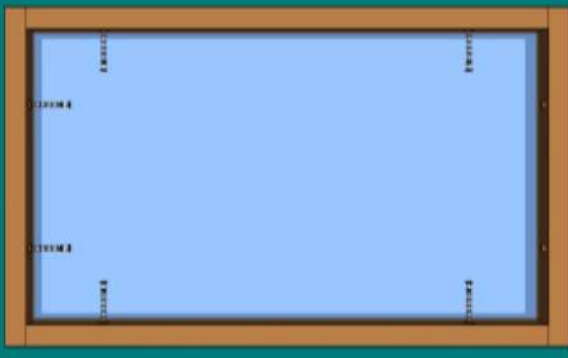

5

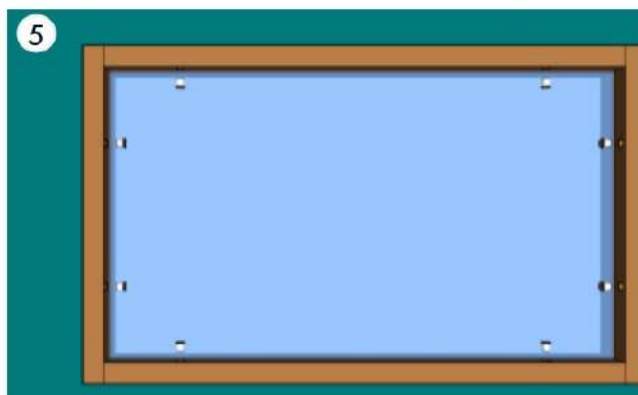

6

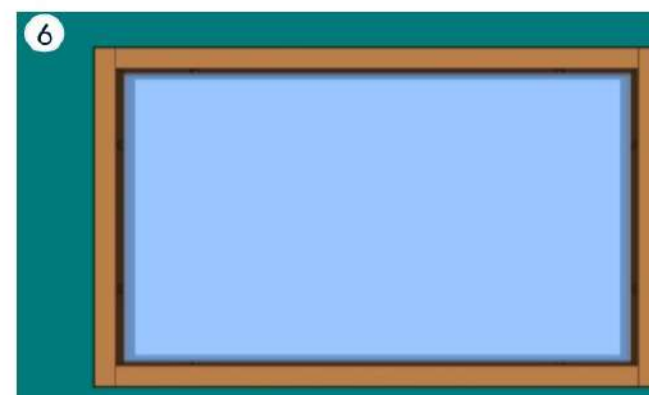



# VERRIÈRES BOIS – POSE SOL / PLAFOND

**Coupe horizontale**

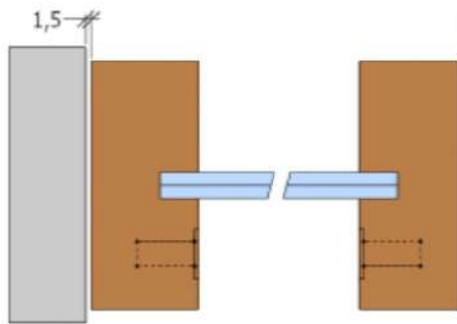

**Coupe haute**

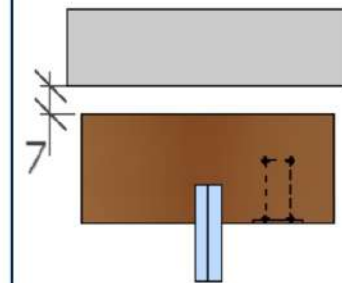

**Coupe basse**

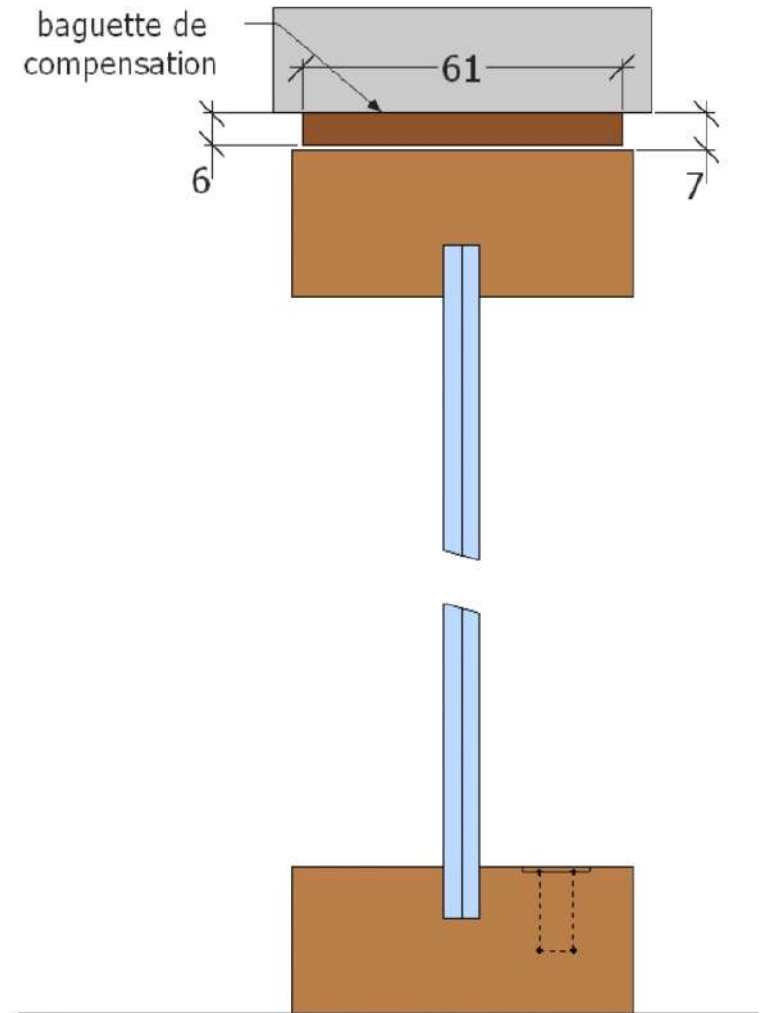
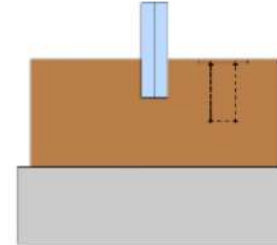



## VERRIÈRES BOIS — D'ANGLE

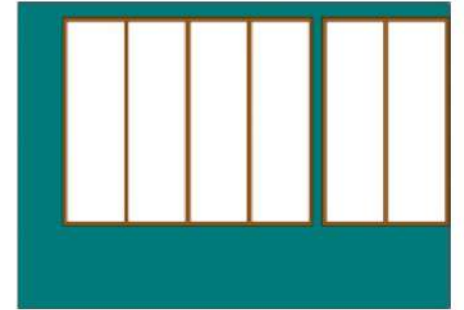

Angle à 90° avec poteau carré

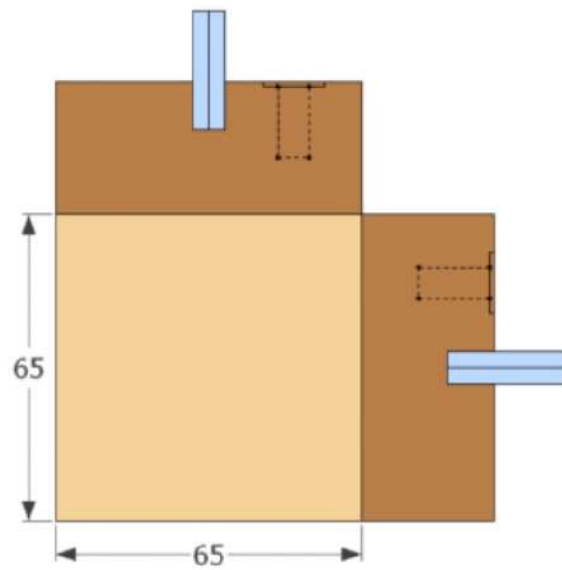

Angle différent de 90° avec tasseau

